

Details shown reflect the most commonly used configurations.
 Contact AWM for additional details and/or assistance.

10/30/19

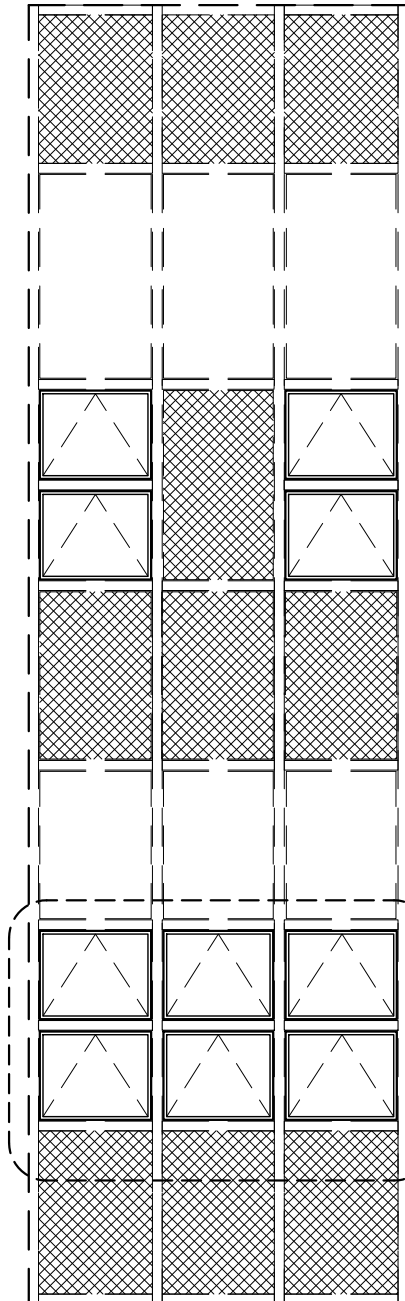

ELEVATION

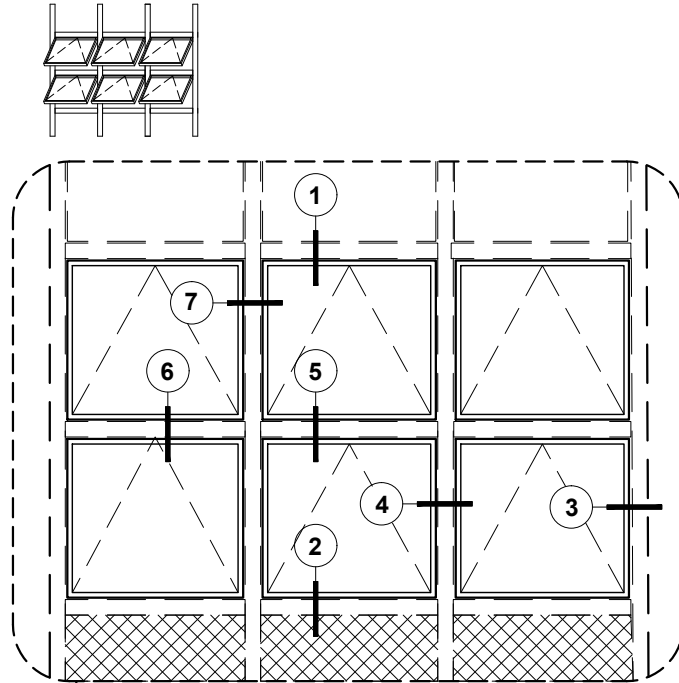

DETAIL ELEVATION

Details shown reflect the most commonly used configurations.
Contact AWM for additional details and/or assistance.

10/30/19

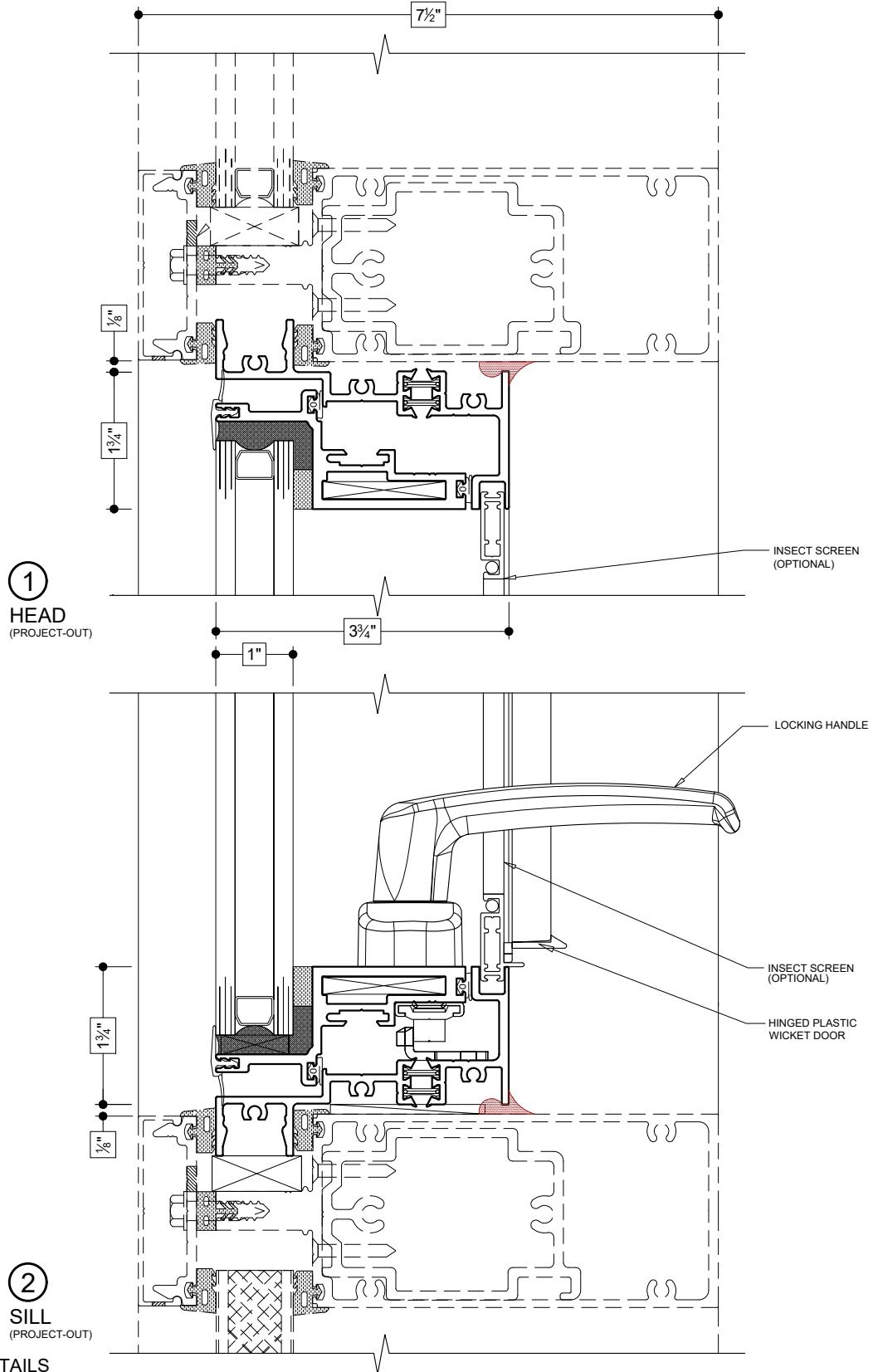

Details shown reflect the most commonly used configurations.
Contact AWM for additional details and/or assistance.

10/30/19

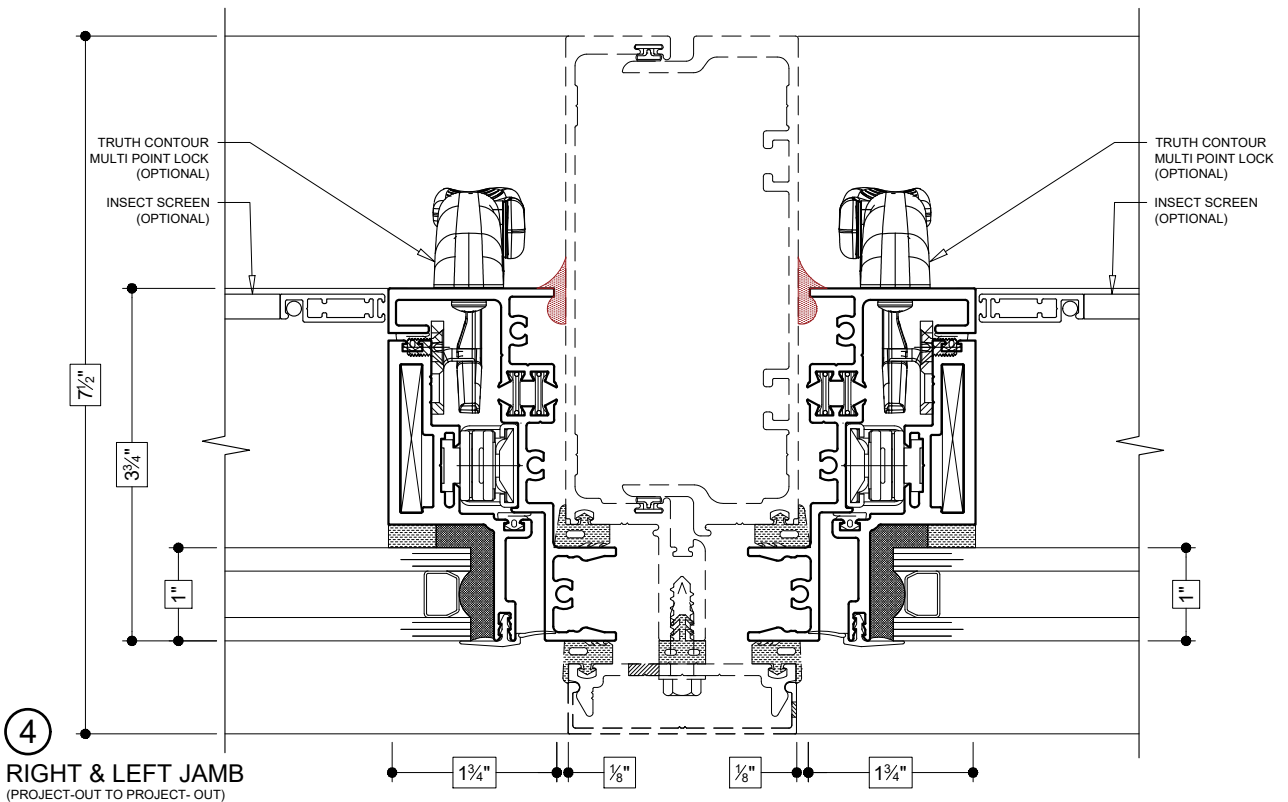
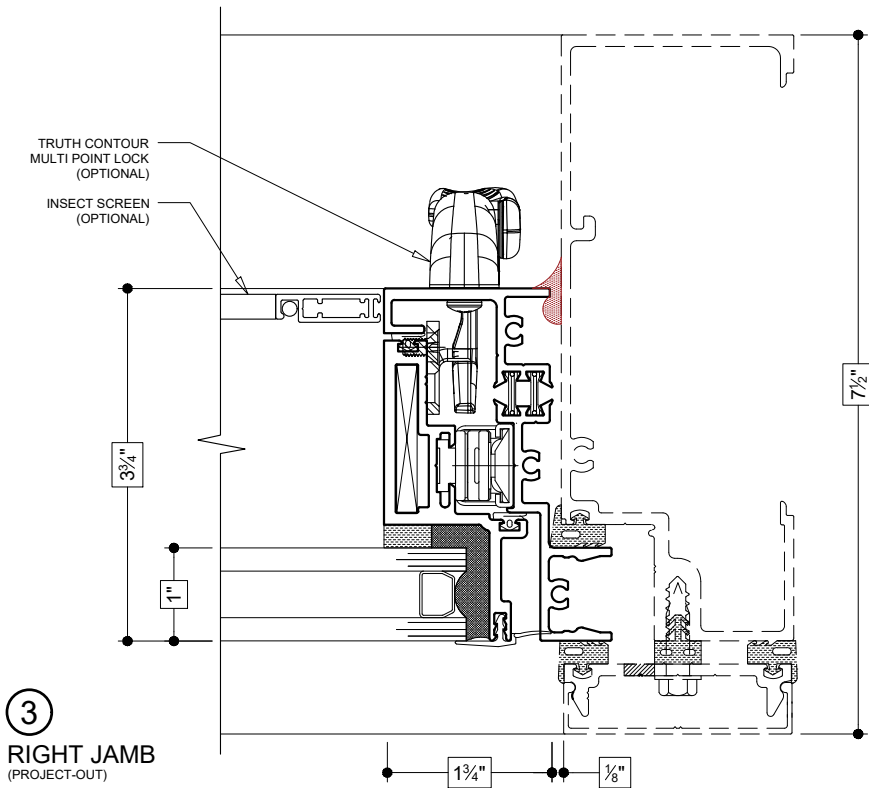

HALF SCALE DETAILS

PAGE 3 OF 5

Details shown reflect the most commonly used configurations.
Contact AWM for additional details and/or assistance.

10/30/19

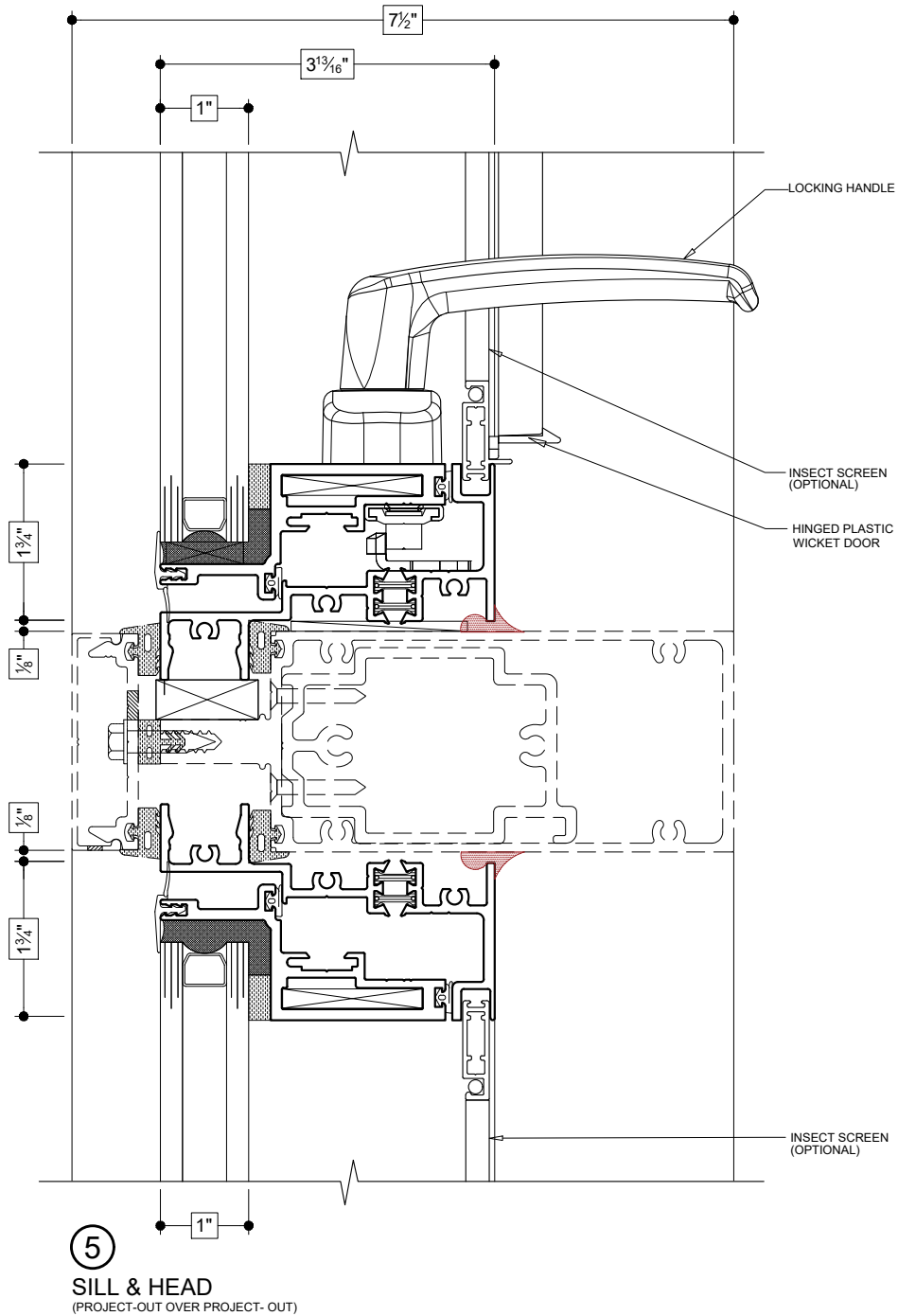

Details shown reflect the most commonly used configurations.
Contact AWM for additional details and/or assistance.

10/30/19

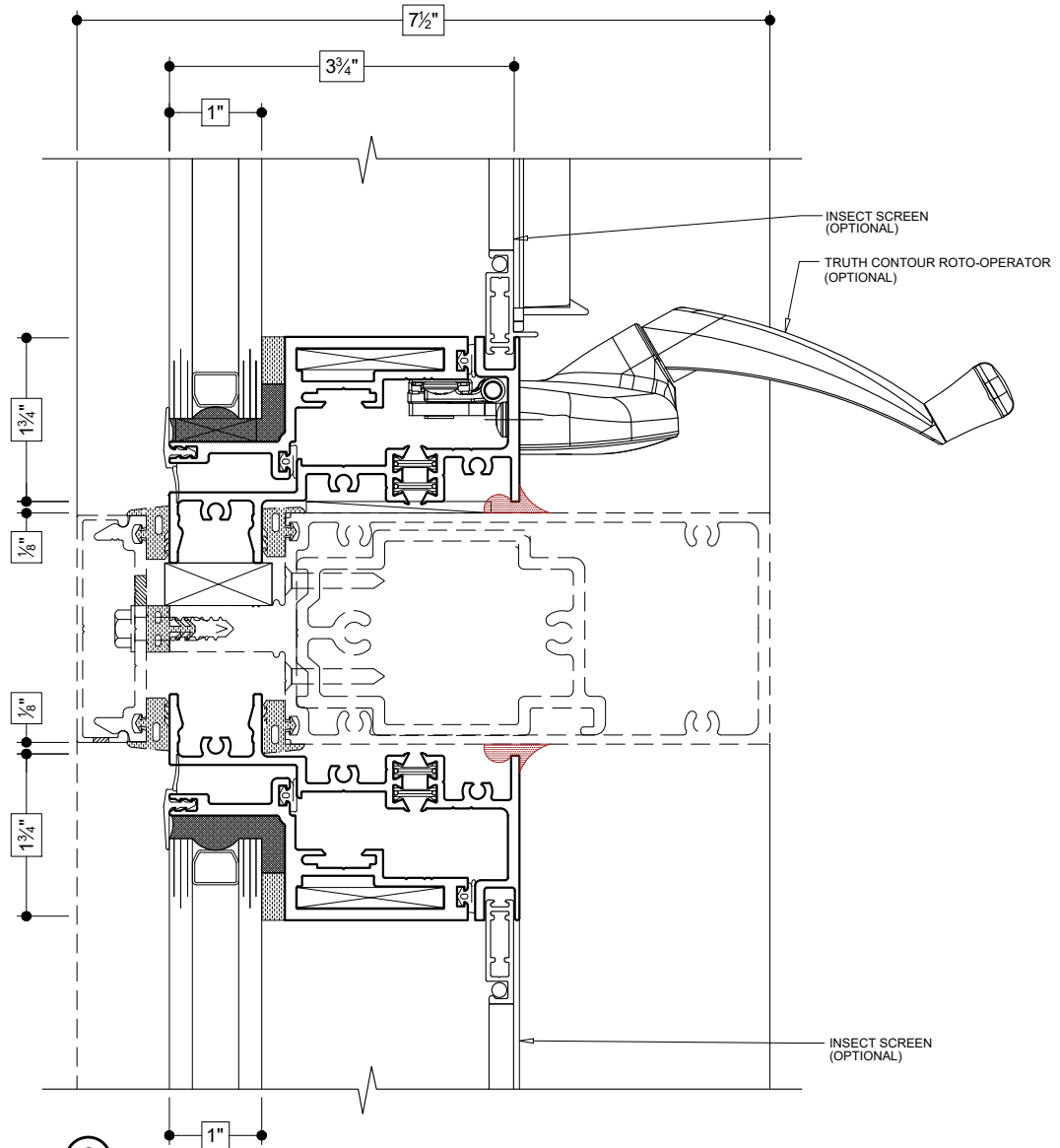

6
SILL & HEAD
(PROJECT-OUT OVER PROJECT-OUT)